

DIE NO : 2954/SB	MATERIAL REF : WS.65-70.1	HARDNESS : 65-70°SH	DIE NO : 2955/SB	MATERIAL REF : WS.65-70.1	HARDNESS : 65-70°SH
------------------	---------------------------	---------------------	------------------	---------------------------	---------------------

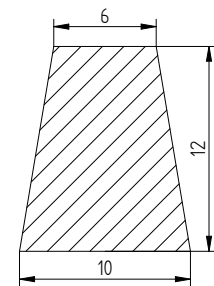

DIE NO : 2921/SB	MATERIAL REF : WS.55.1	HARDNESS : 55°SH	DIE NO : 2763/SB	MATERIAL REF : WS.60.1	HARDNESS : 60°SH
------------------	------------------------	------------------	------------------	------------------------	------------------

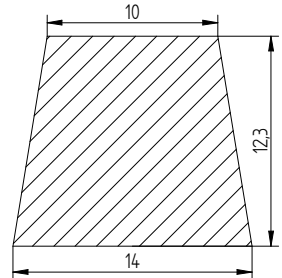
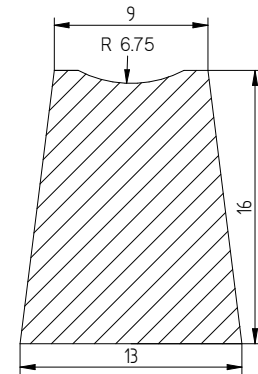
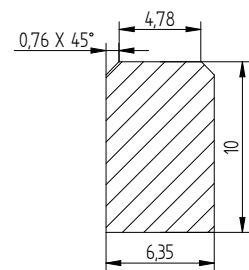

DIE NO : 2720/SB	MATERIAL REF : WS.60.1	HARDNESS : 60°SH	DIE NO : 2439/SB	MATERIAL REF : NGP.60.	HARDNESS : 60°SH
------------------	------------------------	------------------	------------------	------------------------	------------------

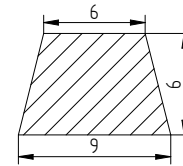
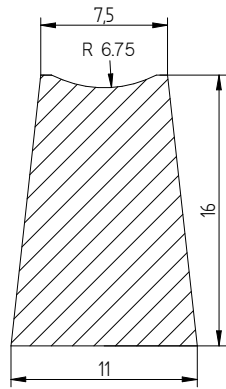

DIE NO : 2348/SB

MATERIAL REF : NPG.60

HARDNESS : 60°SH

DIE NO : 1938/SB

MATERIAL REF : WS.60.1

HARDNESS : 60°SH

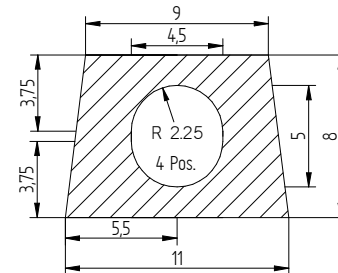
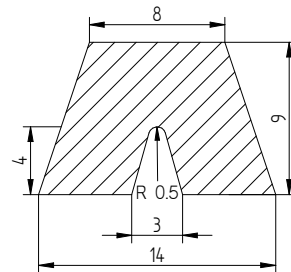

DIE NO : 2054/SB

MATERIAL REF : WS.60.1

HARDNESS : 60°SH

DIE NO : 2375/SB

MATERIAL REF : WS.60.1

HARDNESS : 60°SH

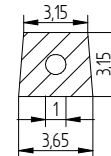
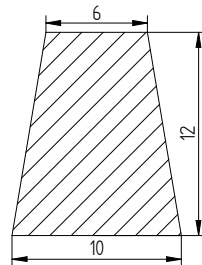

DIE NO : 2763/SB

MATERIAL REF : WS.60.1

HARDNESS : 60°SH

DIE NO : 2745/SB

MATERIAL REF : WS.60.1

HARDNESS : 60°SH

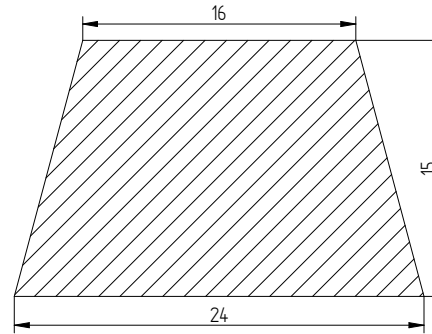
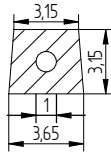

DIE NO : 2744/SB	MATERIAL REF : WS.75.1	HARDNESS : 75°SH	DIE NO : 2215/SB	MATERIAL REF : WS.40.1	HARDNESS : 40°SH
------------------	------------------------	------------------	------------------	------------------------	------------------

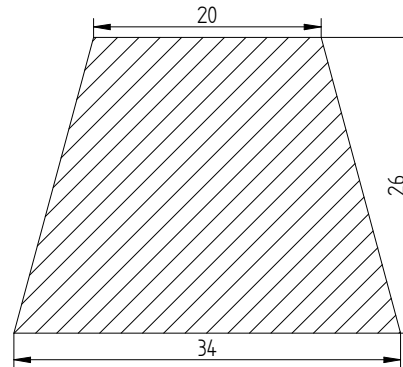
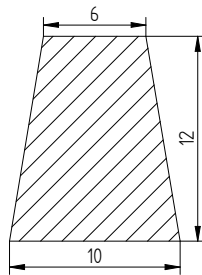

DIE NO : 2187/SB	MATERIAL REF : WS.60.1	HARDNESS : 60°SH	DIE NO : 2129/SB	MATERIAL REF : WS.60.1	HARDNESS : 60°SH
------------------	------------------------	------------------	------------------	------------------------	------------------

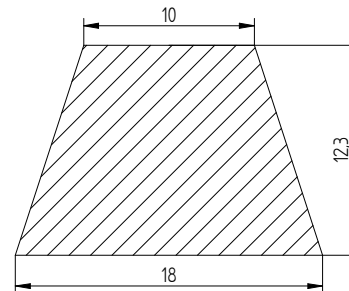
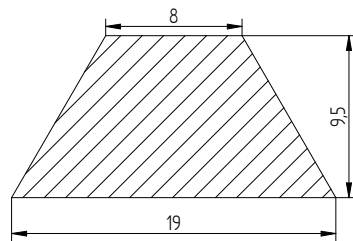

DIE NO : 2078/SB	MATERIAL REF : WS.40.1	HARDNESS : 40°SH	DIE NO : 2087/SB	MATERIAL REF : WS.55.1	HARDNESS : 55°SH
------------------	------------------------	------------------	------------------	------------------------	------------------

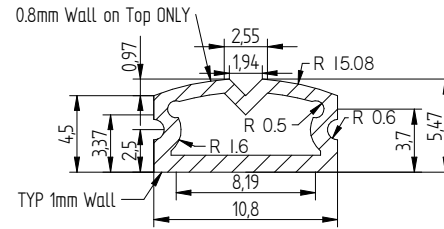
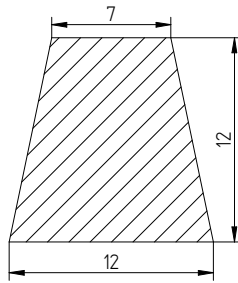

DIE NO : 2041/SB	MATERIAL REF : WS.60.1	HARDNESS : 60°SH	DIE NO : 2942/SB	MATERIAL REF : WS.70.1	HARDNESS : 70°SH
------------------	------------------------	------------------	------------------	------------------------	------------------

DIE NO :	MATERIAL REF :	HARDNESS : °SH	DIE NO :	MATERIAL REF :	HARDNESS : °SH
----------	----------------	----------------	----------	----------------	----------------

DIE NO :	MATERIAL REF :	HARDNESS : °SH	DIE NO :	MATERIAL REF :	HARDNESS : °SH
----------	----------------	----------------	----------	----------------	----------------